

## HIGH-SPEED OPERATIONAL AMPLIFIER

### ■ GENERAL DESCRIPTION

The NJM318 is a precision high-speed operational amplifier, which designed for applications requiring wide bandwidth and high slew rate. They feature a factor of ten increases in speed over general purpose devices without sacrificing DC performance.

The NJM318 has internal unity gain frequency compensation. This considerably simplifies its application since no external components are necessary for operation. However, unlike most internally compensated amplifiers, external frequency compensation may be added for optimum performance. For inverting applications, feedforward compensation will boost the slew rate to over 150V/μs and almost double the bandwidth. Overcompensation can be used with the amplifier for greater stability when maximum bandwidth is not needed. Further, a single capacitor can be added to reduce the 0.1% setting time to under 1μs.

The high speed and fast setting time of these op amps make them useful in A/D converters, oscillators, active filters, sample and hold circuits, or general purpose amplifiers. These devices are easy to apply and offer an order of magnitude better AC performance than industry standards such as the NJM741.

### ■ PACKAGE OUTLINE

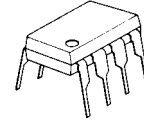

NJM318D

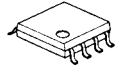

NJM318M

### ■ FEATURES

- Operating Voltage ( ±5V~±20V )
- Wide Unity Gain Bandwidth ( 15MHz typ. )
- High Slew Rate ( 70V/μs typ. )
- Package Outline DIP8,DMP8
- Bipolar Technology

### ■ PIN CONFIGURATION

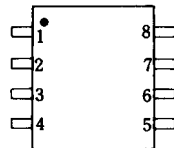

NJM318D  
NJM318M

#### PIN FUNCTION

1. BAL/COMP1
2. -INPUT
3. +INPUT
4. V<sup>-</sup>
5. BAL/COMP3
6. OUTPUT
7. V<sup>+</sup>
8. COMP2

### ■ EQUIVALENT CIRCUIT

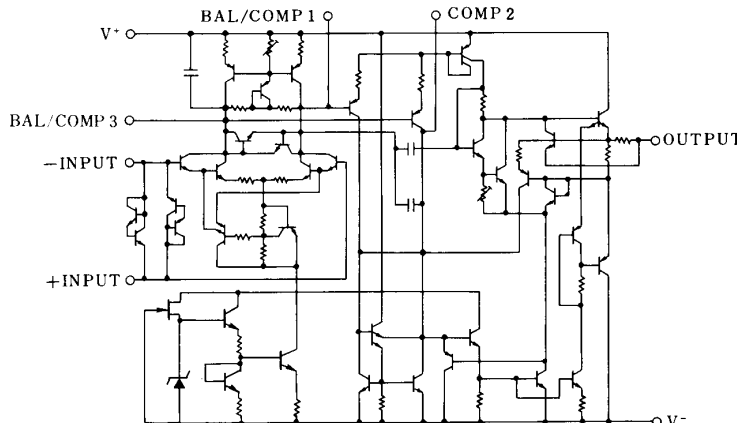

# NJM318

## ■ ABSOLUTE MAXIMUM RATINGS

( Ta=25°C )

PARAMETER	SYMBOL	RATINGS	UNIT
Supply Voltage	$V^+ / V^-$	± 20	V
Differential Input Voltage	$V_{IC}$	± 10mA ( note1 )	V
Input Voltage ( note )	$V_{ID}$	± 15V ( note2 )	V
Power Dissipation	$P_D$	( DIP8 ) 500 ( DMP8 ) 300	mW
Operating Temperature Range	$T_{opr}$	-40~+85	°C
Storage Temperature Range	$T_{stg}$	-40~+125	°C

( note1 ) A current limiting resistance is required when the input voltage is higher than 1V.

( note2 ) For supply voltage less than ±15V, the absolute maximum input voltage is equal to the supply voltage.

## ■ ELECTRICAL CHARACTERISTICS

( Ta=+25°C,  $V^+ / V^- = \pm 15V$  )

PARAMETER	SYMBOL	TEST CONDITION	MIN.	TYP.	MAX.	UNIT
Input Offset Voltage	$V_{IO}$		-	4	10	mV
Input Offset Current	$I_{IO}$		-	30	200	nA
Input Bias Current	$I_{IB}$		-	150	500	nA
Input Resistance	$R_{IN}$		0.5	-	-	MΩ
Operating Current	$I_{CC}$		-	5	10	mA
Large Signal Voltage Gain	$A_V$	$R_L \geq 2k\Omega, V_O = \pm 10V$	88	106	-	dB
Slew Rate	SR	$A_V = 1, R_S = 10k\Omega$	50	70	-	V/μs
Unity Gain Bandwidth	$f_T$		-	15	-	MHz
Input Common Mode Voltage Range	$V_{ICM}$		± 11.5	-	-	V
Common Mode Rejection Ratio	CMR		70	100	-	dB
Supply Voltage Rejection Ratio	SVR		65	80	-	dB
Output Voltage Swing	$V_{OM}$	$R_L = 2k\Omega$	± 12	± 13	-	V

## ■ TYPICAL CHARACTERISTICS

**Input Bias Current, Input Offset Current vs. Temperature**

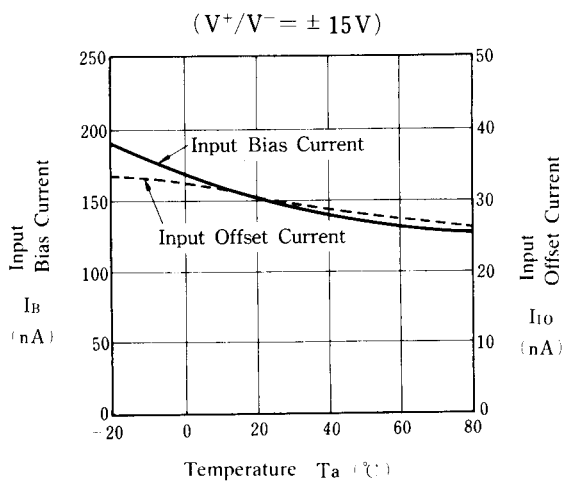

**Voltage Gain vs. Operating Voltage**

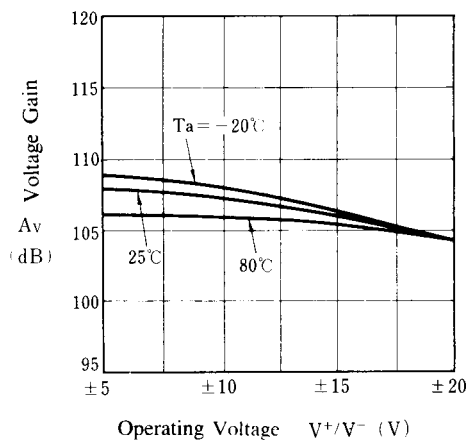

**Supply Voltage Rejection vs. Frequency**

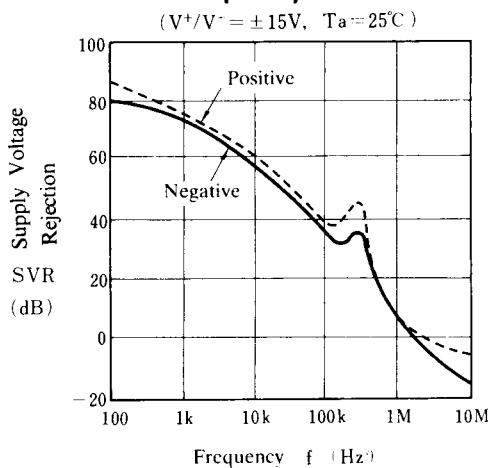

**Common Mode Rejection vs. Frequency**

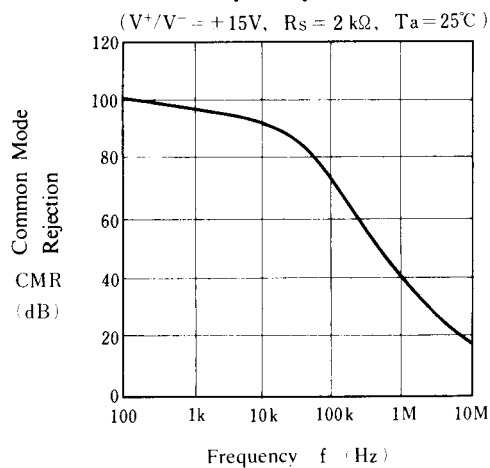

**Current Limiting**

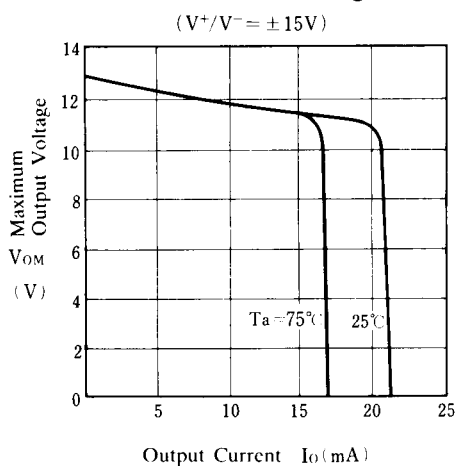

**Differential Input Current vs. Differential Input Voltage**

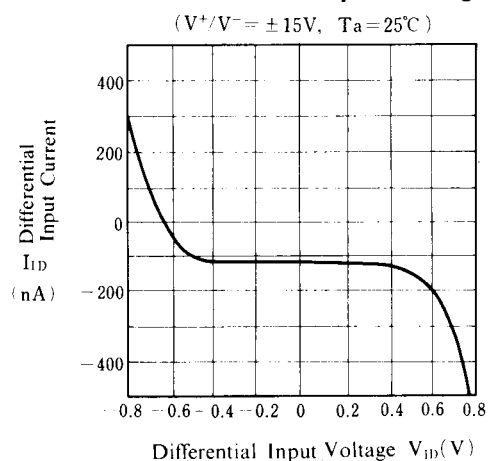

## ■ TYPICAL CHARACTERISTICS

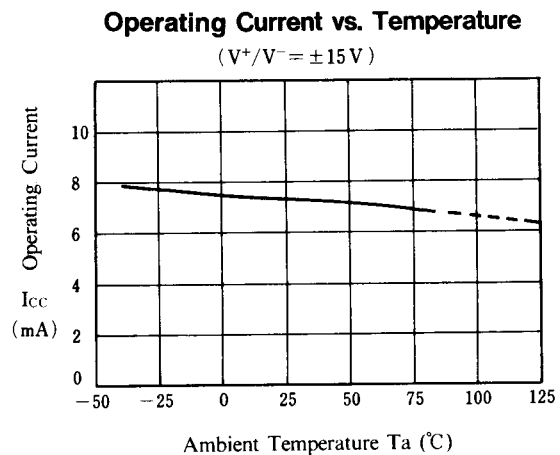
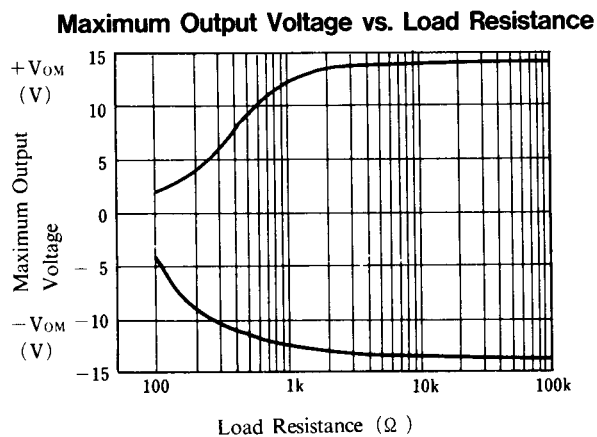
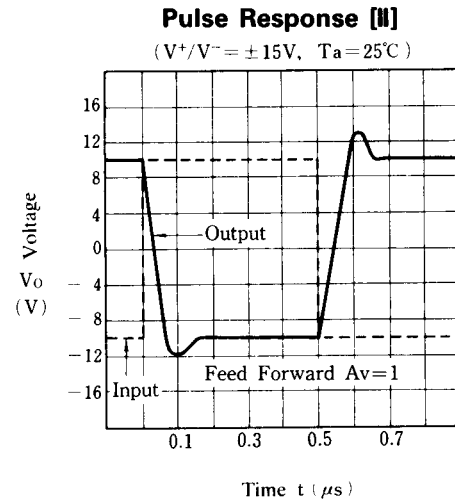
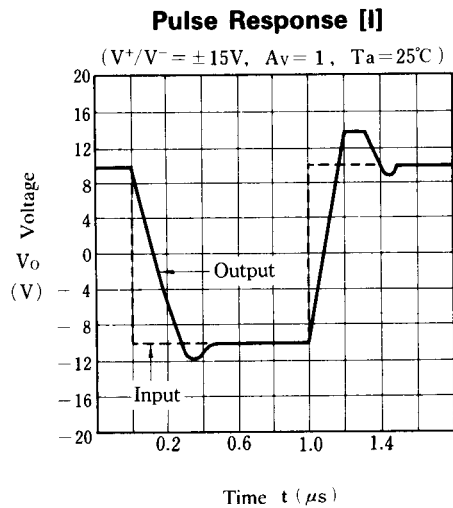
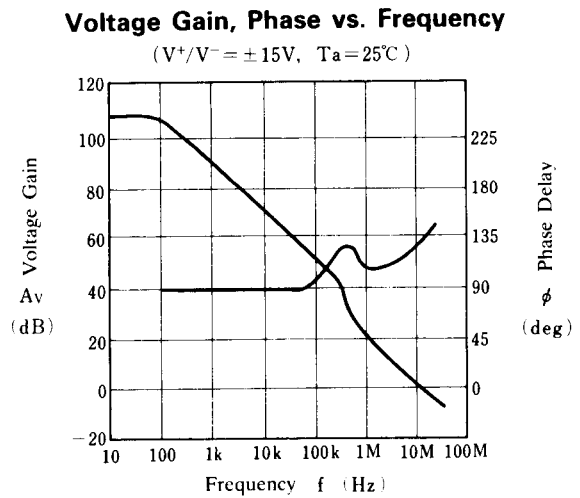
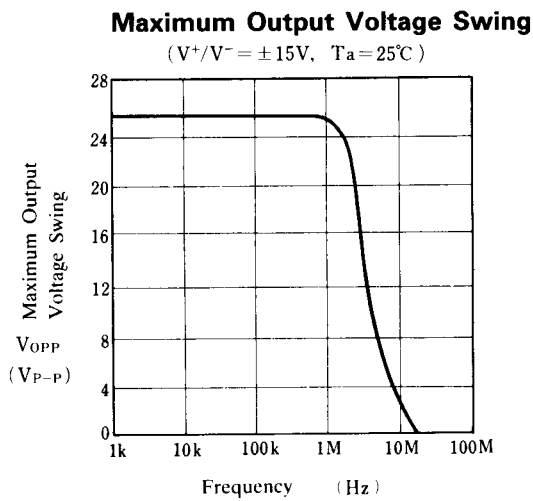

## ■ TYPICAL CHARACTERISTICS

### Maximum Output Voltage vs. Temperature

( $V^+/V^- = \pm 15\text{ V}$ ,  $R_L = 2\text{ k}\Omega$ )

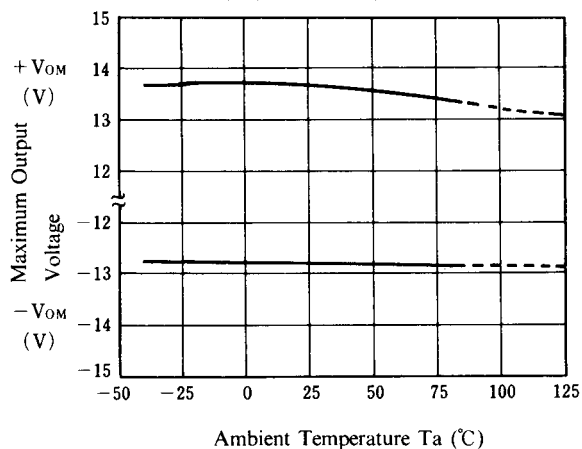

### Input Bias Current vs. Temperature

( $V^+/V^- = \pm 15\text{ V}$ )

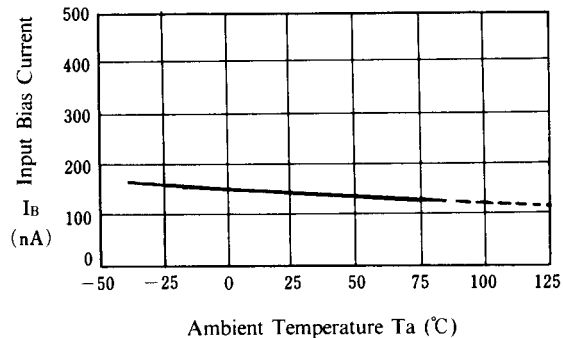

### Input Offset Voltage vs. Temperature

( $V^+/V^- = \pm 15\text{ V}$ )

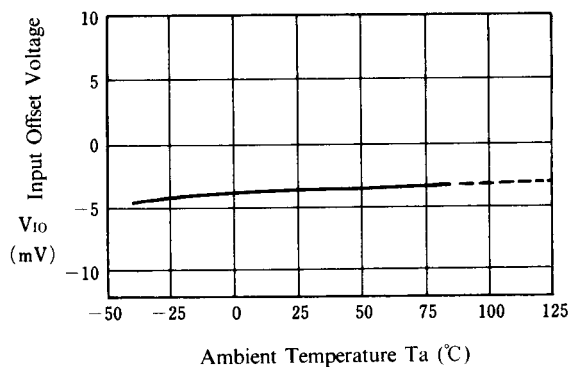

## ■ ADJUSTMENT METHOD

○ offset Adjustment

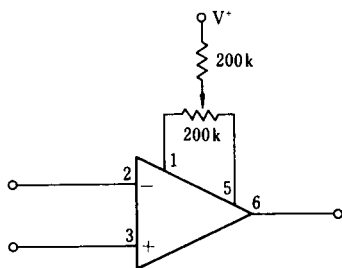

○ Feedforward Compensation

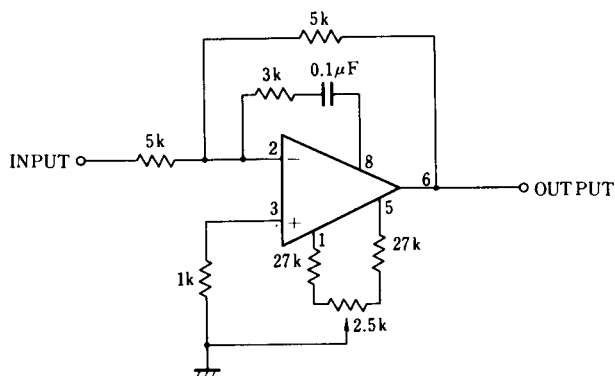

**[CAUTION]**

The specifications on this databook are only given for information, without any guarantee as regards either mistakes or omissions. The application circuits in this databook are described only to show representative usages of the product and not intended for the guarantee or permission of any right including the industrial rights.